

LM3519

High Frequency Boost White LED Driver with High-Speed PWM Brightness Control

General Description

The LM3519 drives up to 4 white LEDs with constant current to provide LCD backlighting in handheld devices. The LED current is internally set to 20mA. The series connection allows the LED current to be identical for uniform brightness and minimizes the number of traces to the LEDs. Brightness control is achieved by applying a PWM signal on enable with frequencies up to 30kHz.

The LM3519 features a proprietary PFM regulation architecture with switching frequencies between 2MHz to 8MHz, minimizing inductor size.

Over-voltage protection circuitry and high frequency operation permit the use of low-cost small output capacitors. During shutdown, the output is disconnected from the input in order to avoid leakage current path through the LEDs to ground.

The LM3519 is available in a tiny 6-pin SOT23 package.

Features

- Drives 2 to 4 LEDs at 20mA
- Up to 30kHz PWM Dimming Control Capability
- >80% Peak Efficiency
- Up to 8MHz Switching Frequency
- Small External Components: 1 μ H - 3.3 μ H(typ.2.2 μ H) Inductor and 1 μ F Output Capacitor
- True Shutdown Isolation
- Over-Voltage Protection
- Wide Input Voltage Range: 2.7V to 5.5V
- Small Footprint SOT23-6 Package

Applications

- LCD, White LED Backlighting on Mobile Phones
- Digital Still Cameras and PDAs
- General Purpose LED Lighting in Handheld Devices

Typical Application

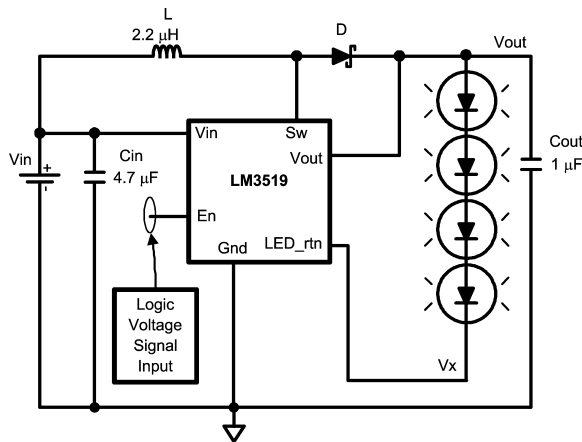

20160201

FIGURE 1. Typical Application Circuit

Connection Diagram

6-Lead SOT23 Package

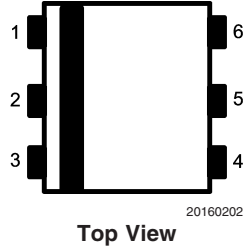

Pin Descriptions

Pin #	Name	Description
1	En	Device Enable Connection
2	Gnd	Ground Connection
3	V _{OUT}	Output Voltage Connection
4	LED_rtn	White LED Current Sensing Input Connection
5	S _W	Drain Connection of the Internal Power Field Effect Transistor (FET) Switch
6	V _{IN}	Input or Supply Voltage Connection

Ordering Information

Current Option	Order Number	Package Marking	Supplied As
20 mA	LM3519MK-20	D52B	1000 Units, Tape-and-Reel
	LM3519MKX-20	D52B	3000 Units, Tape-and-Reel

Absolute Maximum Ratings (Note 1)

If Military/Aerospace specified devices are required, please contact the National Semiconductor Sales Office/Distributors for availability and specifications.

V_{IN} , E_n , & LED_rtn Pin	-0.3V to +6.5V
V_{OUT} , Sw Pin	-0.3V to +21V
Maximum Junction Temperature (T_{J-MAX})	+150°C
Storage Temperature Range	-65°C to +150°C

ESD Rating (Note 2)

Human Body Model:	2kV
Machine Model:	200V

Operating Ratings

Junction Temperature (T_J) Range	-40°C to +125°C
Ambient Temperature (T_A) Range	-40°C to +85°C
Input Voltage Range	2.7V to 5.5V

Thermal Properties (Note 4)

Junction-to-Ambient Thermal Resistance (θ_{JA})	220°C/W
--	---------

Electrical Characteristics (Note 5) Limits in standard typeface are for $T_J = +25^\circ\text{C}$. Limits in **bold typeface** apply over the full operating junction temperature range ($-40^\circ\text{C} \leq T_J \leq +125^\circ\text{C}$). $V_{IN} = 3.6\text{V}$, unless otherwise stated.

Symbol	Parameter	Conditions	Min	Typ	Max	Units
I_Q	Supply Current	Shutdown: $V_{EN} = 0\text{V}$		0.1		μA
		Not Switching: $V_{EN} = 1.8\text{V}$		360	500	
		Switching: $V_{EN} = 1.8\text{V}$, LED_rtn current = 30mA		550	900	
$I_{LED(TOL)}$	LED Current Tolerance/Variation	$V_{IN} = 3.6\text{V}$, 2.2 μH , 4LEDs	-10	5.5	10	%
OVP	Over-Voltage Protection Threshold	OVP ON OVP OFF	18 17.8	18.9 18.6	20 19.8	V
I_{LIM}	Switch Current Limit	$L = 2.2\mu\text{H}$		750		mA
$R_{DS(ON)}$	Power NMOS Switch ON Resistance			455		m Ω
$I_{LEAKAGE}$	Switch Leakage	$V_{SW} = 3.6\text{V}$, $V_{EN} = 0\text{V}$		0.1	2	μA
$R_{LED_rtn(ON)}$	LED_rtn NMOS Switch ON Resistance			8.0		Ω
F_S	Switching Frequency	$I_{LED} = 20\text{ mA}$, $L = 1\mu\text{H}$ 4LEDs		5.4		MHz
I_{EN}	Enable Pin Bias Current (Note 3)	$V_{EN} = 0\text{V}$		0.1		μA
		$V_{EN} = 1.8\text{V}$		1.1	2	
En	Enable Threshold	Device On Device Off	0.9		0.3	V

Note 1: Absolute maximum ratings indicate limits beyond which damage to the device may occur. Operating Ratings are conditions under which operation of the device is guaranteed. Operating Ratings do not imply guaranteed limits. For guaranteed performance limits and associated test conditions, see the Electrical Characteristics table.

Note 2: The human body model is a 100pF capacitor discharged through a 1.5k Ω resistor into each pin. The machine model is a 200pF capacitor discharged directly into each pin.

Note 3: Current flows into the pin.

Note 4: The maximum allowable power dissipation is a function of the maximum junction temperature, $T_{J(MAX)}$, the junction-to-ambient thermal resistance, θ_{JA} , and the ambient temperature, T_A . See Thermal Properties for the thermal resistance. The maximum allowable power dissipation at any ambient temperature is calculated using: $P_D(MAX) = (T_{J(MAX)} - T_A)/\theta_{JA}$. Exceeding the maximum allowable power dissipation will cause excessive die temperature.

Note 5: Min and max limits are guaranteed by design, test, or statistical analysis. Typical numbers are not guaranteed, but do represent the most likely norm.

Block Diagram

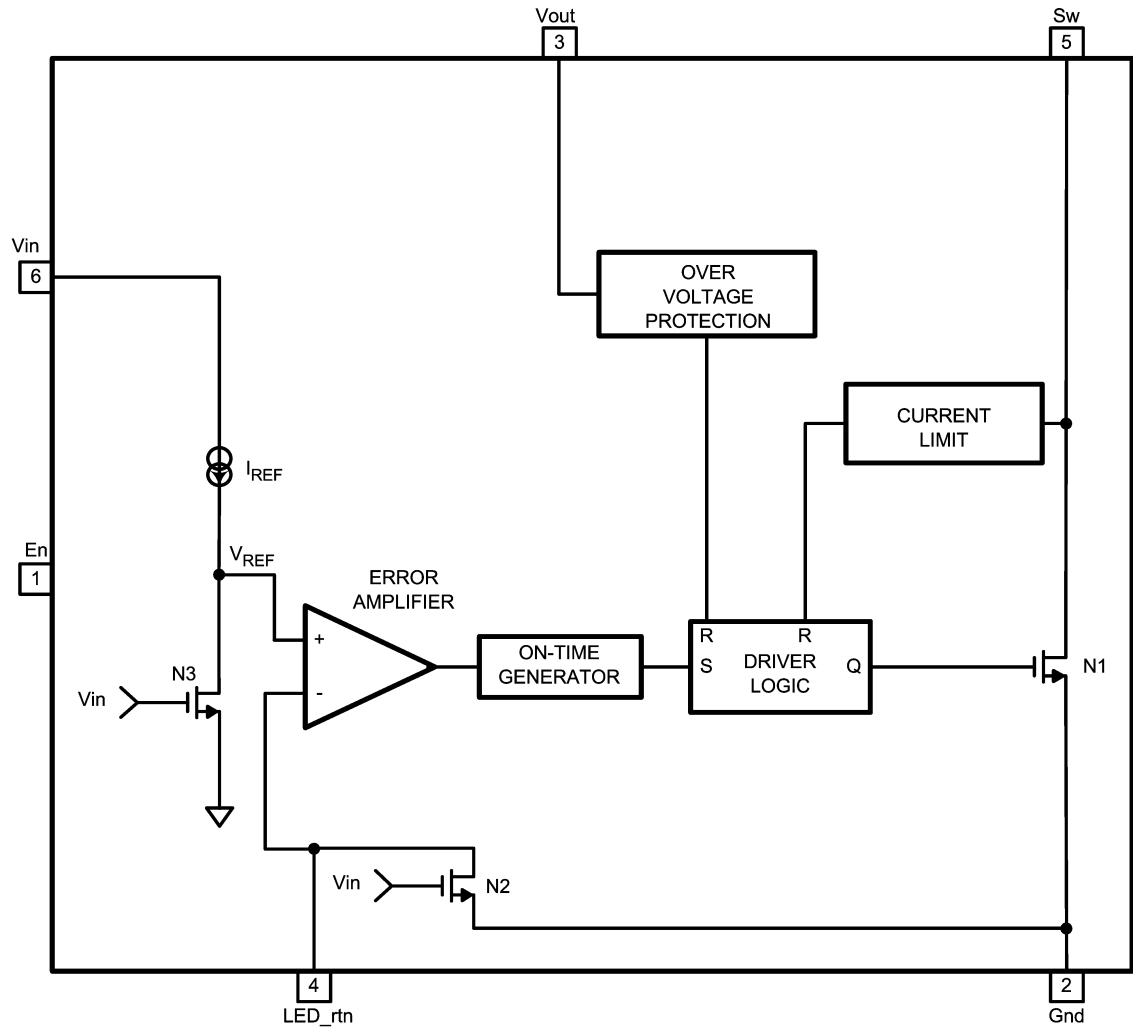

20160203

FIGURE 2. Block Diagram

Circuit Description

The LM3519 is a step-up converter for white LED applications that uses a unique and proprietary pulse frequency modulation (PFM) architecture to optimize high efficiency at high frequency operation. Unlike most PFM architecture implementations, the LM3519's unique architectural implementation results in non-pulse skipping variable frequency operation. The regulator is forced to operate at the edge of Continuous Conduction Mode (CCM). The error amplifier will set the end of the on-time (I_{PEAK} of inductor) based on the load (LEDs) current. During this operation, the inductor current ramps up and reaches a peak current at end of the on-time. At this point, the internal power switch is turned off until the inductor current reaches zero, and the cycle repeats again. The switching frequency is set based on the charge (on-time) and discharge (off-time) of the inductor current. The frequency can range between 2MHz to 8MHz over the operating input range.

The LM3519 operation can be best understood through an examination of the block diagram in *Figure 2*. When LED

current is out of regulation, the LED_rtn voltage falls below or rises above the internal reference voltage (VREF). The error amplifier will output a signal to increase or decrease the proper on-time duration of N1 power FET. This correction allows the inductor's stored energy to increase or decrease to a sufficient level that when transferred to the load will bring the LED_rtn current back into regulation.

During steady-state operation for a typical switching cycle, the oscillator sets the driver logic and turns on N1 power device. N1 conducts current through the inductor and reverse biases the external diode. The LED current is supplied by the output capacitor when N1 is conducting. Once N1 on-time period is concluded, the internal power device is turned off and the external diode is forward biased. The inductor current then flows through the diode to the LED load to replenish the output capacitor and keep the LED current regulated at the trimmed target.

Typical Performance Characteristics (See Typical Application Circuit : $V_{IN} = 3.6V$, $C_{IN} = 4.7\mu F$ and $C_{OUT} = 1\mu F$, $L = 2.2\mu H$ and 4 LEDs. $T_A = +25^\circ C$, unless otherwise stated.)

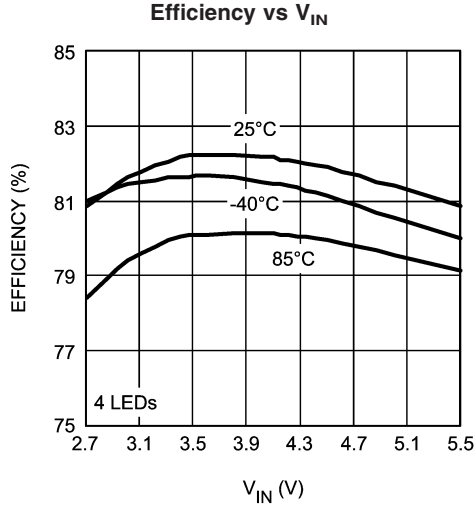

20160251

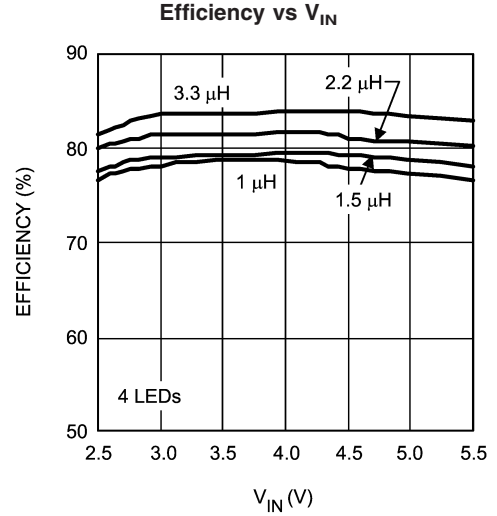

20160231

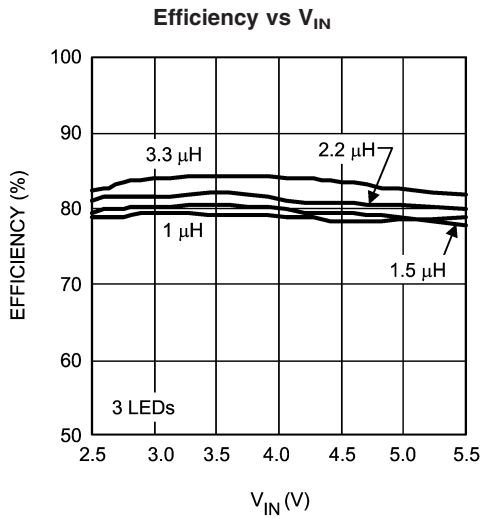

20160232

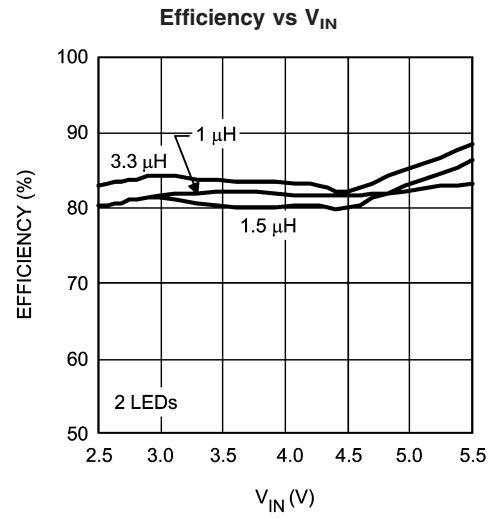

20160233

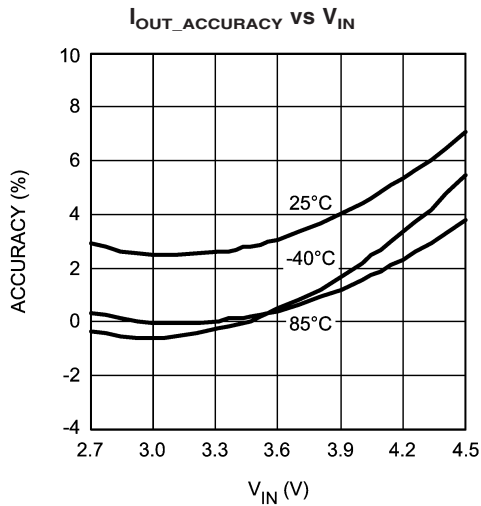

20160249

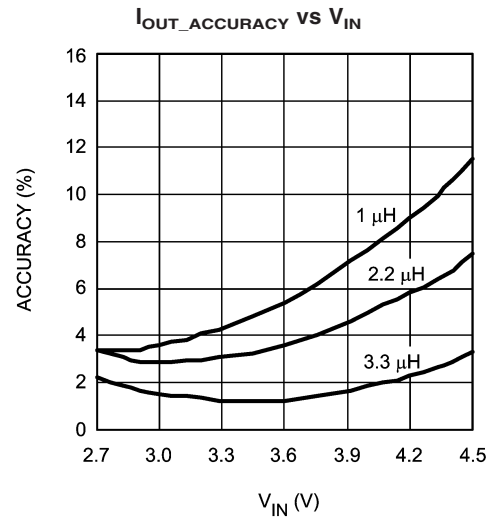

20160250

Typical Performance Characteristics (See Typical Application Circuit : $V_{IN} = 3.6V$, $C_{IN} = 4.7\mu F$ and $C_{OUT} = 1\mu F$, $L = 2.2\mu H$ and 4 LEDs. $T_A = +25^\circ C$, unless otherwise stated.) (Continued)

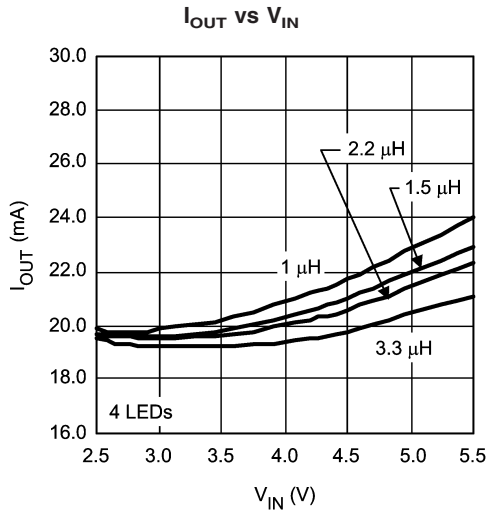

20160234

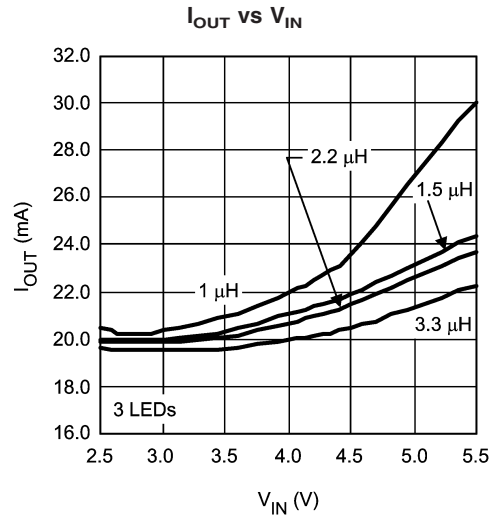

20160235

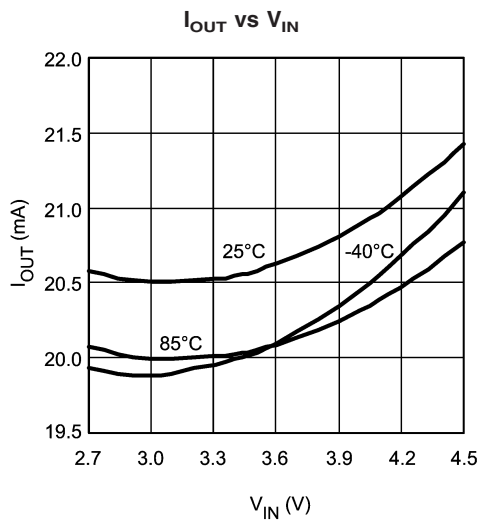

20160253

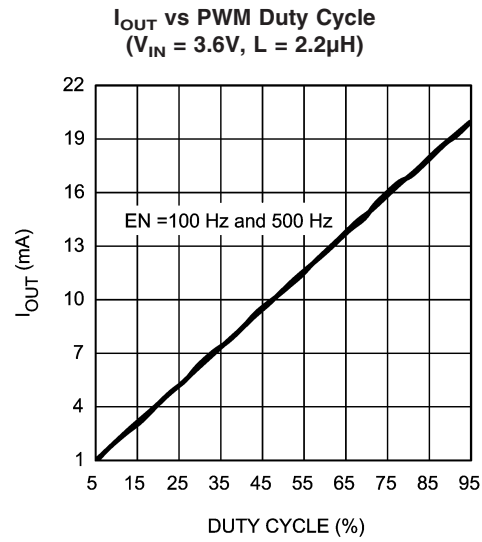

20160260

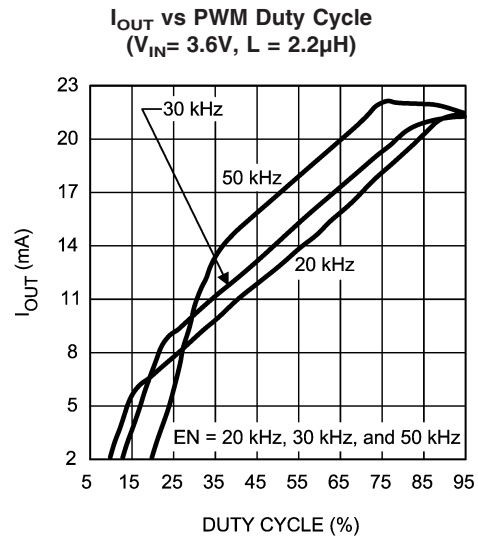

20160261

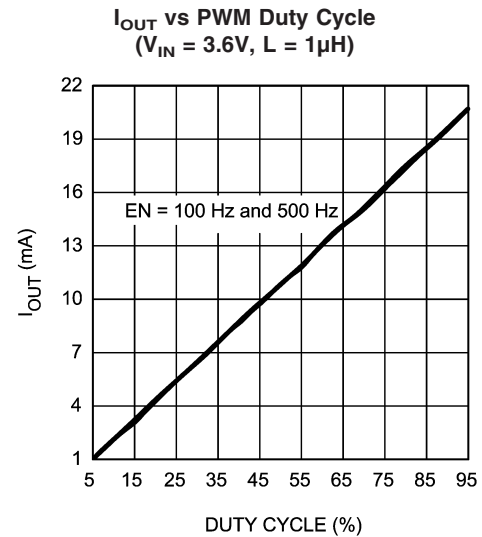

20160259

Typical Performance Characteristics (See Typical Application Circuit : $V_{IN} = 3.6V$, $C_{IN} = 4.7\mu F$ and $C_{OUT} = 1\mu F$, $L = 2.2\mu H$ and 4 LEDs. $T_A = +25^\circ C$, unless otherwise stated.) (Continued)

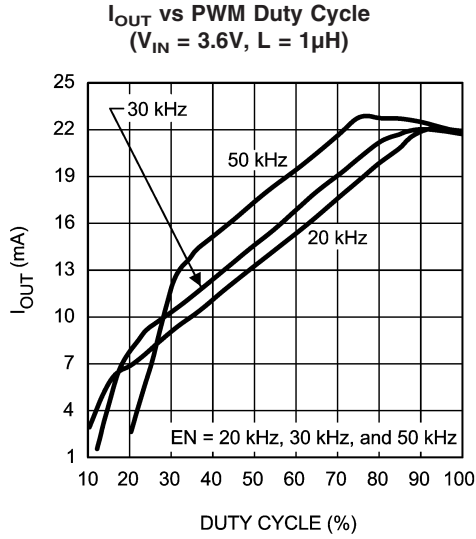

20160244

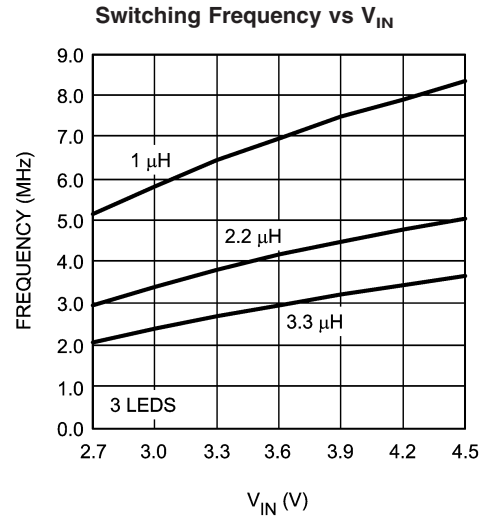

20160207

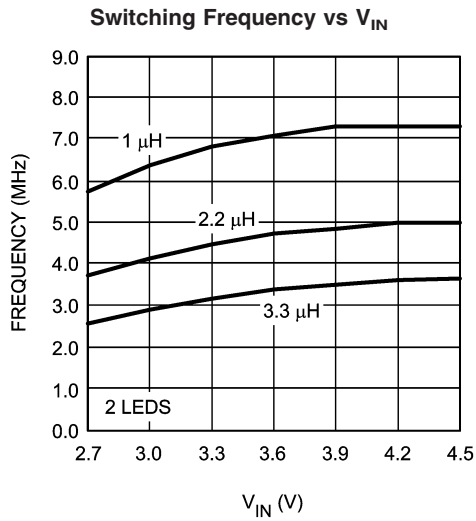

20160209

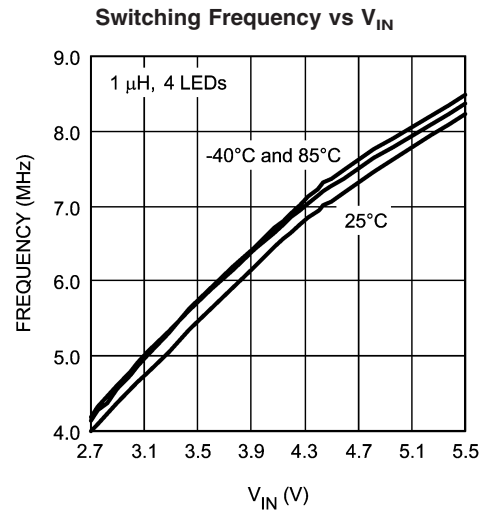

20160245

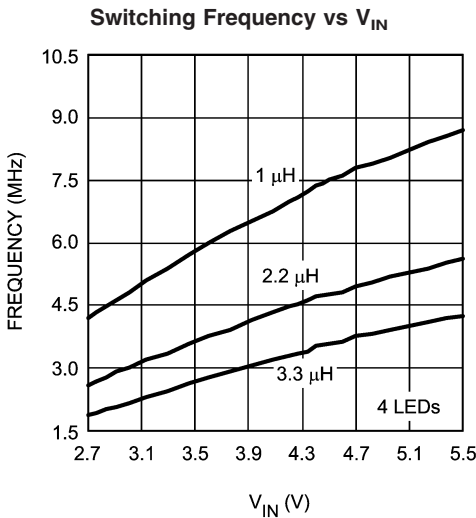

20160246

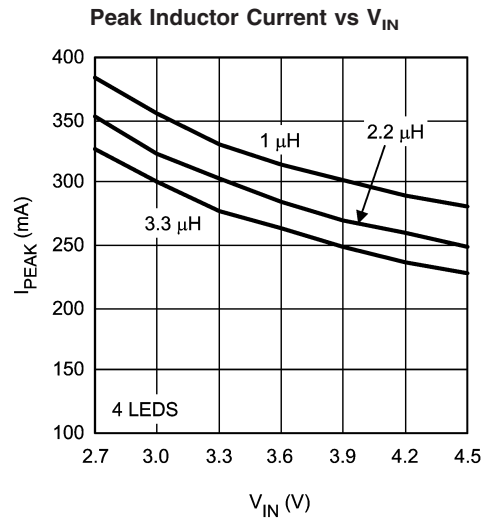

20160204

Typical Performance Characteristics (See Typical Application Circuit : $V_{IN} = 3.6V$, $C_{IN} = 4.7\mu F$ and $C_{OUT} = 1\mu F$, $L = 2.2\mu H$ and 4 LEDs. $T_A = +25^\circ C$, unless otherwise stated.) (Continued)

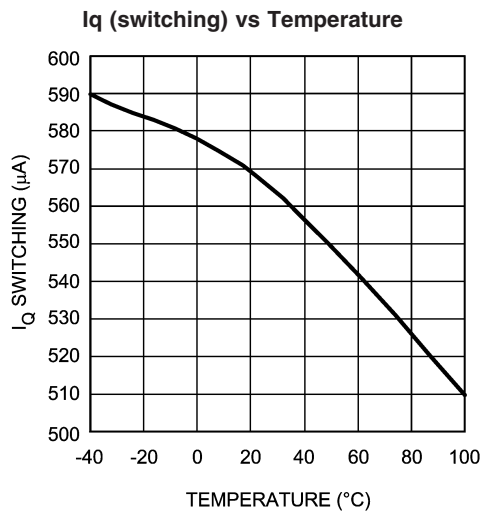
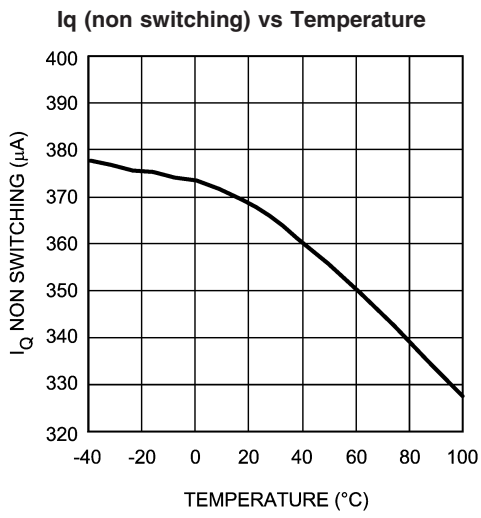
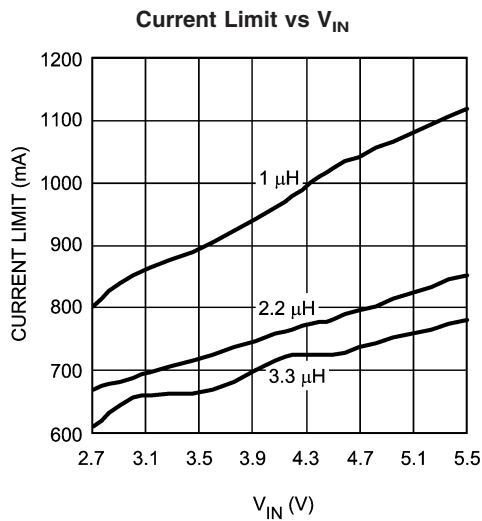
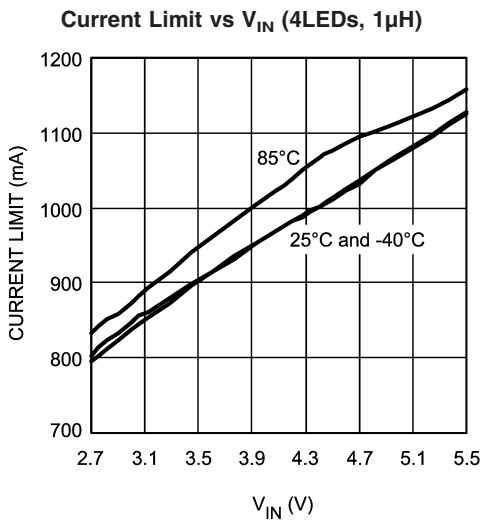
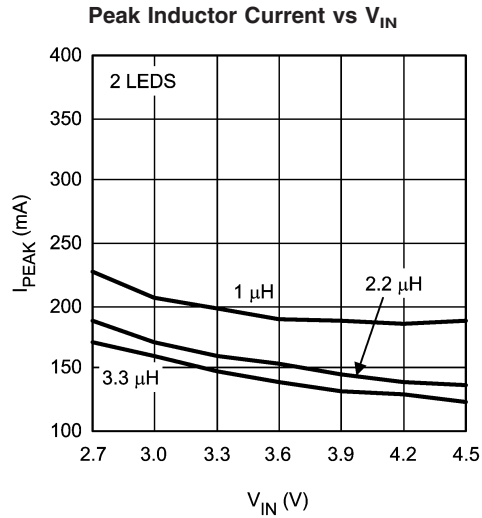
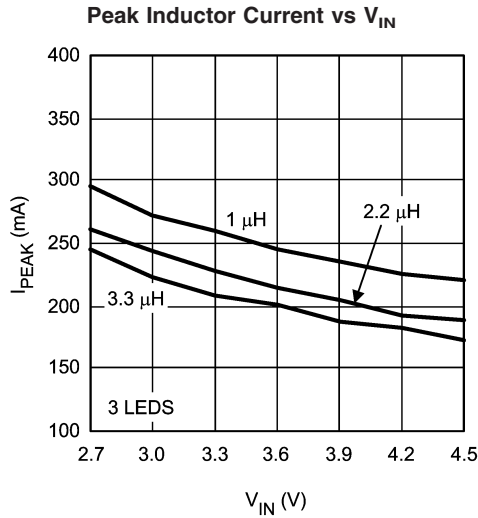

Typical Performance Characteristics (See Typical Application Circuit : $V_{IN} = 3.6V$, $C_{IN} = 4.7\mu F$ and $C_{OUT} = 1\mu F$, $L = 2.2\mu H$ and 4 LEDs. $T_A = +25^\circ C$, unless otherwise stated.) (Continued)

LED Switch R_{DS_ON} vs Temperature

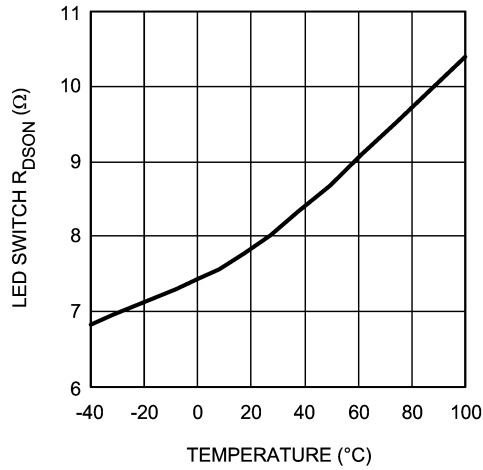

20160257

Power Switch R_{DS_ON} vs Temperature

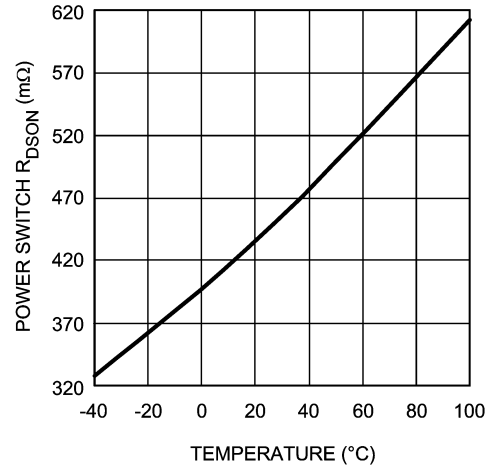

20160258

Start-up, ($V_{IN} = 3.6V$, 4LEDs, $2.2\mu H$)

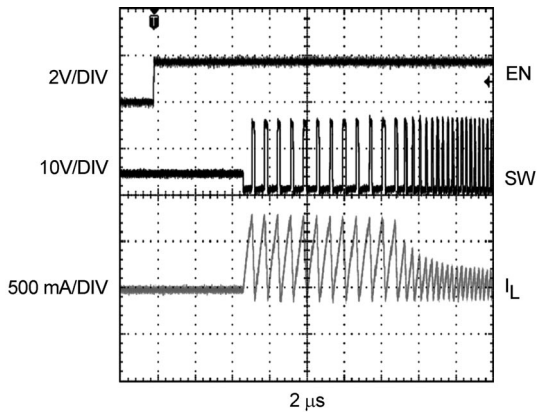

20160210

Start-up ($V_{IN} = 3.6V$, 4LEDs, $3.3\mu H$)

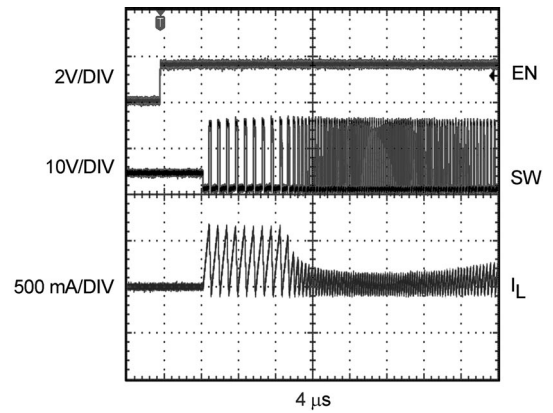

20160219

Start-up ($V_{IN} = 3.6V$, 2LEDs, $3.3\mu H$)

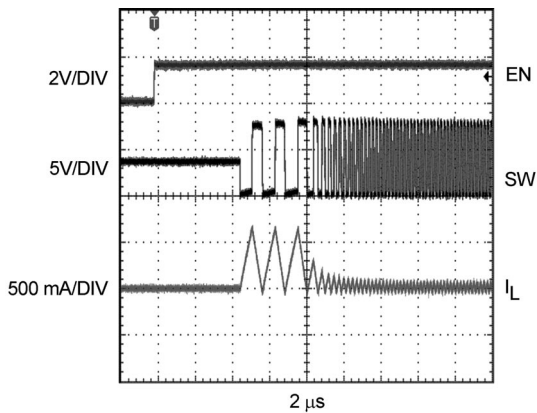

20160220

Start-up, ($V_{IN} = 3.6V$, 2LEDs, $2.2\mu H$)

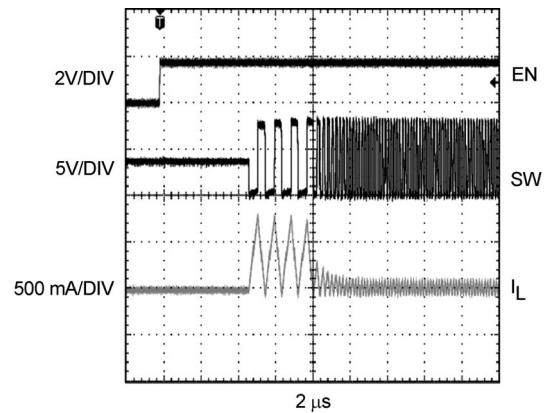

20160211

Typical Performance Characteristics (See Typical Application Circuit : $V_{IN} = 3.6V$, $C_{IN} = 4.7\mu F$ and $C_{OUT} = 1\mu F$, $L = 2.2\mu H$ and 4 LEDs. $T_A = +25^\circ C$, unless otherwise stated.) (Continued)

Typical Switching Waveform
($V_{IN} = 3.6V$, 4LEDs, $3.3\mu H$)

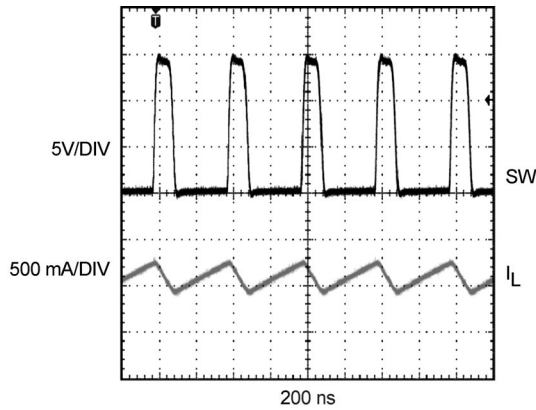

20160218

Typical Switching Waveform
($V_{IN} = 3.6V$, 4LEDs, $2.2\mu H$)

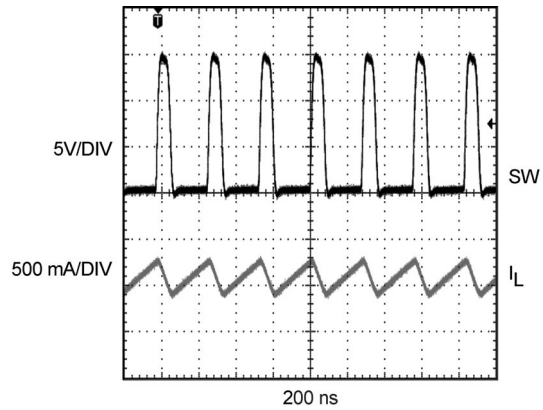

20160212

Typical Switching Waveform
($V_{IN} = 3.6V$, 3LEDs, $2.2\mu H$)

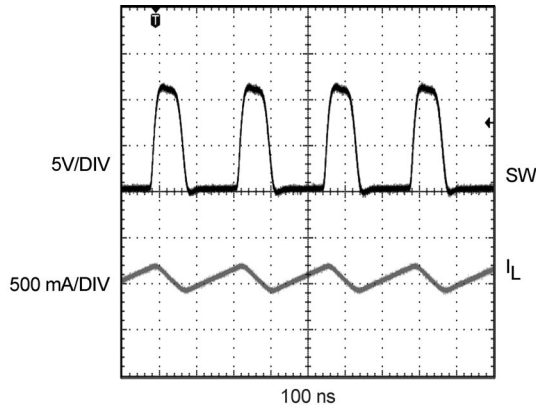

20160214

Typical Switching Waveform
($V_{IN} = 3.6V$, 2LEDs, $2.2\mu H$)

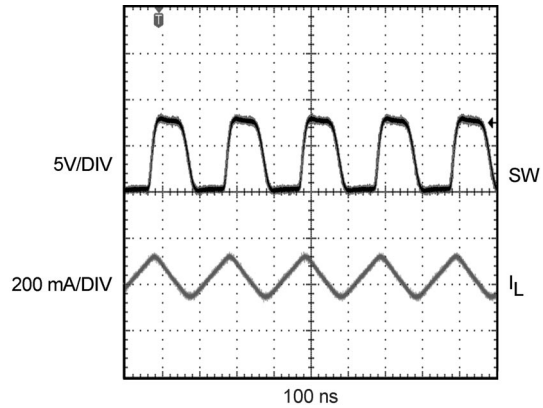

20160215

Typical Switching Waveform
($V_{IN} = 3.6V$, 3LEDs, $1\mu H$)

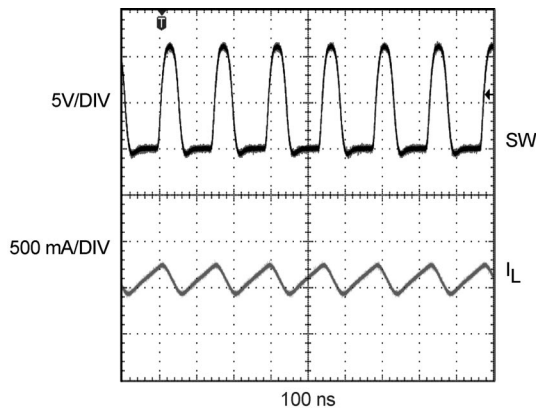

20160228

Typical Switching Waveform
($V_{IN} = 3.6V$, 4LEDs, $1\mu H$)

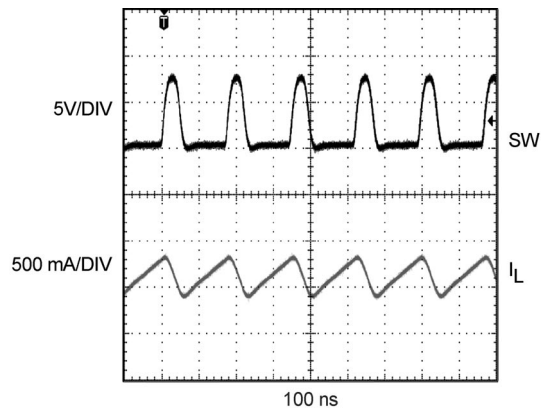

20160229

Application Information

CAPACITOR SELECTION

To minimize output and input voltage ripple, low equivalent series resistance (ESR) ceramic capacitors are the best choice to use for the input and output filters. For most display applications, a 4.7 μ F capacitor is recommended for C_{IN} and 1 μ F for C_{OUT} .

Larger output capacitors can be used to reduce ripple voltage. To guarantee good performance, a minimum of 0.47 μ F C_{OUT} is required to trade off for large ripple voltage. Care must be taken to account for the true capacitance of a multilayer ceramic capacitor. Smaller case size capacitors typically have less capacitance for a given bias voltage as compared to a larger case size capacitor with the same bias voltage. Please confirm with capacitor manufacturer data before selecting the capacitor.

Some recommended capacitor manufacturers include but are not limited to:

Manufacturer	Description	Case Size
AVX	06033D105MAT-25V	0603
	06036D475MAT-6.3V	0603
TDK	C2012X5R1A475M-10V	0805
Taiyo Yuden	TMK212BJ105KG-J	0805
	EM212BJ475MG-16V	0805
muRata	GRM40-034B105K25	0805
	GRM39X5R475K6.3	0603

INDUCTOR SELECTION

In order to maintain sufficient inductance, the saturation current rating of the inductor used with the LM3519 should be higher than the peak inductor current in the target application. Inductors with low DCR values have less power loss and higher efficiency. Larger inductor values such as 2.2 μ H and 3.3 μ H can be used to optimize efficiency, frequency and peak current. If 1 μ H is used, the peak inductor current, frequency will be higher and the efficiency will be lower. Note that the switching frequency ranges will be higher at lower inductance. Typical frequency range is between 4 to 8MHz for 1 μ H, 2 to 5MHz for 2.2 μ H and 2 to 4MHz for 3.3 μ H over the input range. Below is a sample list of low profile inductors.

Some recommended inductor manufacturers include but are not limited to:

Manufacturer	L	Case Size	I_{SAT}
CoilCRAFT: DO3314-102	1 μ H	3.3x3.3x1.4mm	2.1A
	2.2 μ H		1.6A
	3.3 μ H		1.4A
Coilcraft: LPO3310-102ML	1 μ H	3.3x3.3x1.0 mm	1.6A
	2.2 μ H		1.1A
	3.3 μ H		0.95A
Cooper: SD31121R0	1 μ H	3.1x3.1x1.4 mm	2.07A
	2.2 μ H		1.48A
	3.3 μ H		1.15A

Taiyo Yuden: NR3015T1R0N	1 μ H	3.0x3.0x1.5 mm	2.1A
NR3015T2R2M	2.2 μ H		1.48A
NR3015T3R3M	3.3 μ H		1.21A

DIODE SELECTION

Diodes with low forward voltage ratings (V_F) and low junction capacitance magnitudes (C_J or C_T or C_D) are conducive to high efficiency. The chosen diode must have a reverse breakdown voltage rating (V_R and/or V_{RRM}) that is larger than the output voltage. The following criteria should be followed when choosing a diode:

- V_R (Diode Blocking Voltage Range) and V_{RRM} (Diode Peak Repetitive Reverse Voltage Rating) $> V_{OUT}$ (Output Voltage)
- I_F or I_O (Diode Average Forward Current Rating) $\geq I_{LOAD}$ (Load Current)
- I_{FRM} (Diode Peak Repetitive Forward Current Rating) $\geq I_{Lpeak}$ (Peak Inductor Current)

Some recommended diode manufacturers include but are not limited to:

Manufacturer	Description
Vishay	SS12(1A/20V)
	SS14(1A/40V)
	SS16(1A/60V)
Central Semiconductor	CMSH1- 40M(1A/40V)
ONsemi	MBRS1540T3(1.5A/40V)

PWM DIMMING

The LED current is set internally by the LM3519 to 20mA (typical); dimming control may be realized by applying a pulse width modulated (PWM) signal to the En pin. For example, a 50% duty cycle waveform will produce an average current of 10mA. A control signal frequency between 17kHz and 30kHz is suitable for dimming.

Although the LM3519 is capable of operation outside this frequency range, it is not recommended to operate below 17kHz for the following reasons: 1) frequency below 100Hz is likely to cause visible flicker in the light emitted by the LED string. 2) frequency below 17kHz may induce audible noise due to combinations of some capacitance/PCB. A PWM frequency above 30kHz is possible but the current linearity vs duty cycle will be affected.

If it is not possible to operate the dimming control above 17kHz, audible noise emission may be minimized by using capacitors with low susceptibility to piezoelectric induced stresses, such as poly film designs. Minimum audible noise is most likely to occur when the PWM frequency is less than 2kHz. It is recommended that any application using a PWM control signal below 17kHz be thoroughly evaluated for undesirable audible or visible noise.

DRIVING 2 LEDs

The LM3519 is optimized to drive up to 4LEDs. When driving 2LEDs, a minimum inductance of 2.2 μ H is required to maintain good loop regulation and current accuracy. If a smaller inductor is used, the LED current will have more variation with input voltage than a typical application. The following curve illustrates the behavior.

Application Information (Continued)

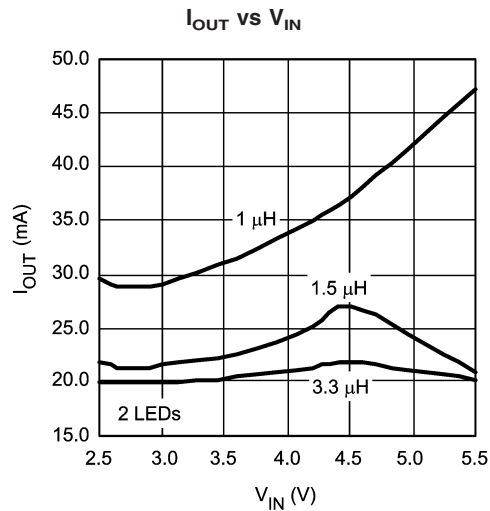

20160239

LAYOUT GUIDELINES

The input capacitor, C_{IN} , must be placed close to the LM3519. Placing C_{IN} close to the device will reduce the metal trace resistance effect on input voltage ripple. Metal trace connections for the C_{OUT} capacitor can increase the effective series resistance, which affects output voltage ripple and efficiency. Trace connections to the inductor should be short and wide to reduce power dissipation, increase overall efficiency and reduce EMI radiation. The diode, like the inductor, should have trace connections that are short and wide to reduce power dissipation and increase overall efficiency. For more details regarding layout guidelines for switching regulators, refer to Applications Note AN-1149.

Physical Dimensions inches (millimeters) unless otherwise noted

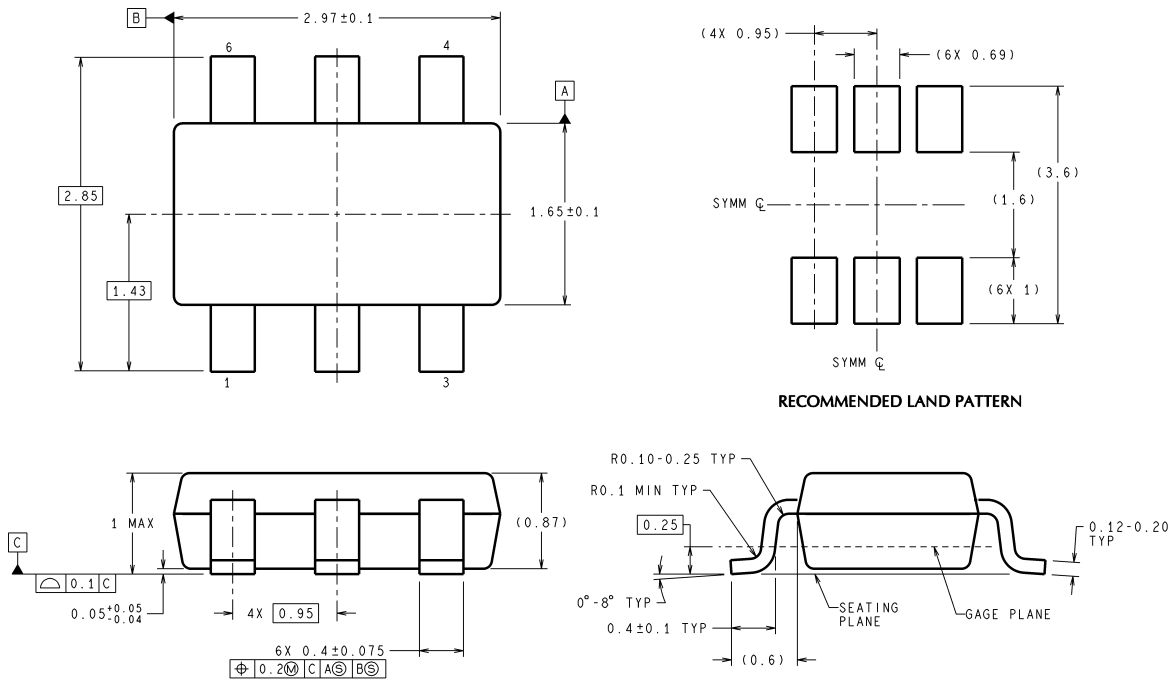

DIMENSIONS ARE IN MILLIMETERS
6-Lead SOT23-6 Package
NS Package Number MK06A

MK06A (Rev D)

National does not assume any responsibility for use of any circuitry described, no circuit patent licenses are implied and National reserves the right at any time without notice to change said circuitry and specifications.

For the most current product information visit us at www.national.com.

LIFE SUPPORT POLICY

NATIONAL'S PRODUCTS ARE NOT AUTHORIZED FOR USE AS CRITICAL COMPONENTS IN LIFE SUPPORT DEVICES OR SYSTEMS WITHOUT THE EXPRESS WRITTEN APPROVAL OF THE PRESIDENT AND GENERAL COUNSEL OF NATIONAL SEMICONDUCTOR CORPORATION. As used herein:

1. Life support devices or systems are devices or systems which, (a) are intended for surgical implant into the body, or (b) support or sustain life, and whose failure to perform when properly used in accordance with instructions for use provided in the labeling, can be reasonably expected to result in a significant injury to the user.
2. A critical component is any component of a life support device or system whose failure to perform can be reasonably expected to cause the failure of the life support device or system, or to affect its safety or effectiveness.

BANNED SUBSTANCE COMPLIANCE

National Semiconductor manufactures products and uses packing materials that meet the provisions of the Customer Products Stewardship Specification (CSP-9-111C2) and the Banned Substances and Materials of Interest Specification (CSP-9-111S2) and contain no "Banned Substances" as defined in CSP-9-111S2.

Leadfree products are RoHS compliant.

National Semiconductor
Americas Customer
Support Center
 Email: new.feedback@nsc.com
 Tel: 1-800-272-9959

National Semiconductor
Europe Customer Support Center
 Fax: +49 (0) 180-530 85 86
 Email: europe.support@nsc.com
 Deutsch Tel: +49 (0) 69 9508 6208
 English Tel: +44 (0) 870 24 0 2171
 Français Tel: +33 (0) 1 41 91 8790

National Semiconductor
Asia Pacific Customer
Support Center
 Email: ap.support@nsc.com

National Semiconductor
Japan Customer Support Center
 Fax: 81-3-5639-7507
 Email: jpn.feedback@nsc.com
 Tel: 81-3-5639-7560